

REV.	ECH NO	LOCATIONS	DESCRIPTION	DATE

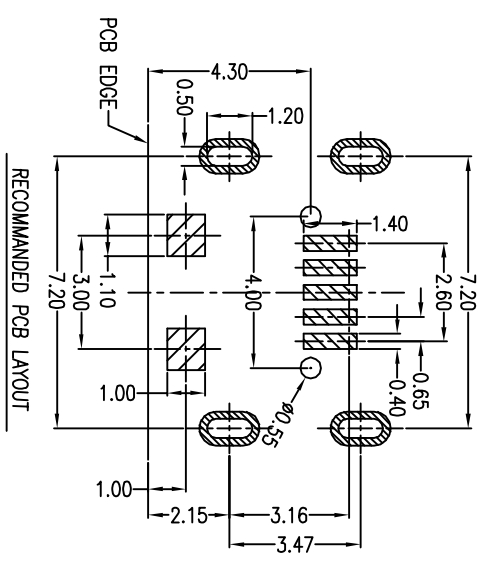
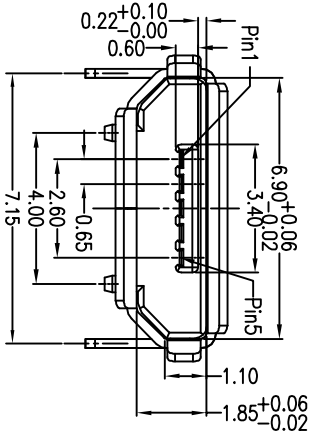
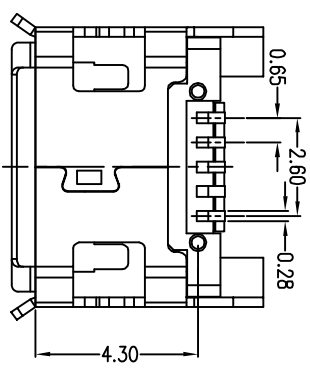
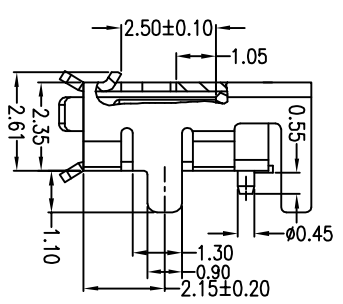
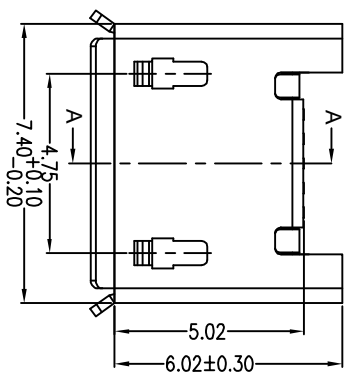
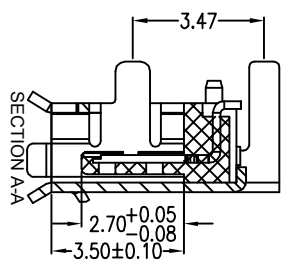
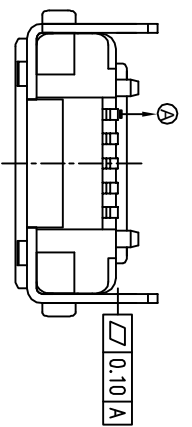

- Note:
- Material:
 - Housing: High temperature thermoplastic with g.f, UL94V-0
 - Contact: copper alloy, t=0.20mm
 - Shell: copper alloy, t=0.25mm
 - Specification:
 - Current rating: 1 A Max. voltage: 100 V(ac) for 1 min.
 - Dielectric withstanding voltage: 100 V(ac) for 1 min.
 - Contact resistance: 50 mW Max.
 - Insulation resistance: 100 MW Min.
 - Total mating force: 3.57 Kgf Max.
 - Total unmating force: 1.0 Kgf Min. 0.81~2.05 Kgf Min.
 - Temperature range: -30°C~80°C

A 01 S B 1 4 1 B 1-276

- 产品代号 A: 精品
- 产品系列 01: micro usb 5pin
- 产品类别 S: 母座
- 产品类型 B: B TYPE
- 外壳材料 1: 2980R-H
- 端子材料 4: 5181R-B
- 主体材质 1: LCP
- 主体颜色 B: 黑色
- 下板类型 1: dip (插板)
- 细节流水 2: 8 micro usb 5P/B Type SMT DIP7 2插板板长1.1四脚全插

PART NO: A01SB141B1-276		MATERIAL: SEE NOTE	
MODEL NO: XX		FINISH: SEE NOTE	
UNIT: MM	SIZE: A4	COLOR: SEE NOTE	TITLE: Micro usb 5P/F B Type SMT DIP7 2 有引脚长1.1四脚全插
TOLERANCE UNSPECIFIED		DR: xiyayulong	DWG NO: A276
.x	0.15	CHK:	REV: A
.xx	0.10	APP:	SCALE: 5:1
.xxx	0.05		DATE: 2012.05.21
Ang.	1°		